

# 20이년 의용계측 중값과사 답

①

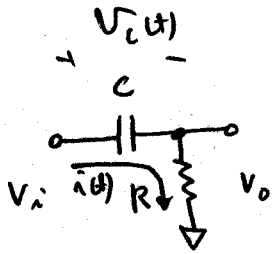

$$i(t) = C \frac{dv_c(t)}{dt} = \frac{v_o(t)}{R}$$

$$v_c(t) = v_i(t) - v_o(t)$$

$$RC \frac{dv_o(t)}{dt} + v_o(t) = RC \frac{dv_i(t)}{dt}$$

$$\frac{v_o(D)}{v_i(D)} = \frac{RC D}{1 + RC D}$$

$$\frac{V_o(j\omega)}{V_i(j\omega)} = \frac{j\omega RC}{1 + j\omega RC} = H(j\omega)$$

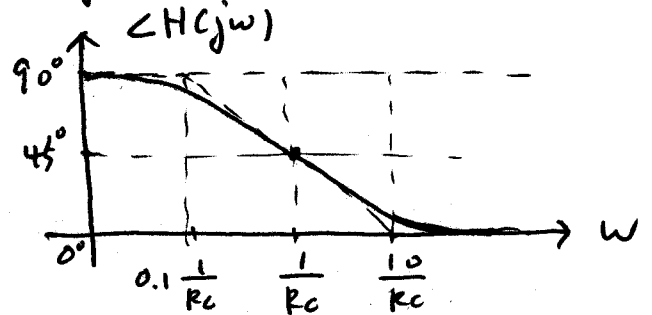
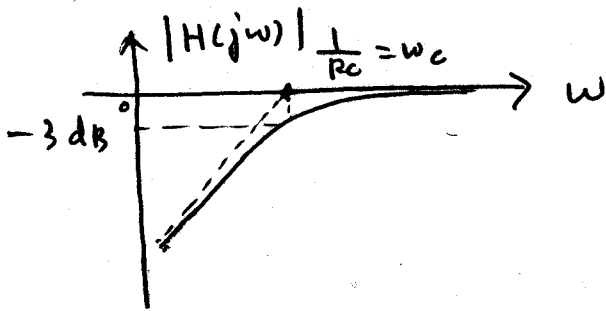

$$f_c = \frac{1}{2\pi RC} \doteq 100 \text{ Hz}$$

$$\angle H(j\omega)|_{\omega=\omega_c} = 45^\circ, \quad |H(j\omega)|_{\omega=\omega_c} = 0.707$$

②

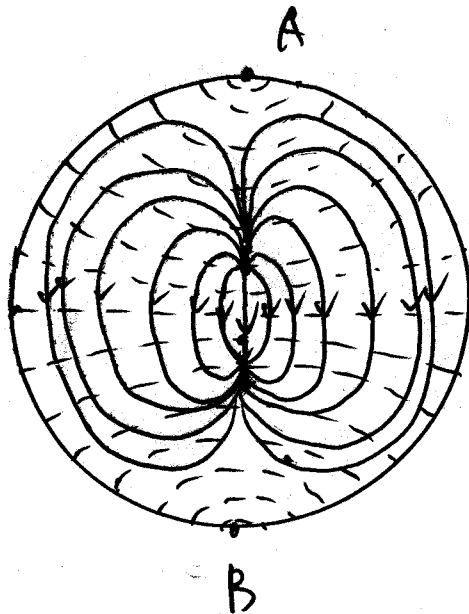

$\Phi_{AB}$  : 전위차

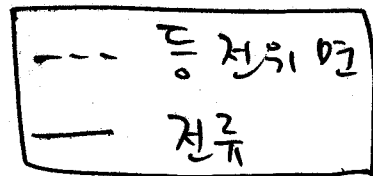

③

P.134 Fig 4.7

④

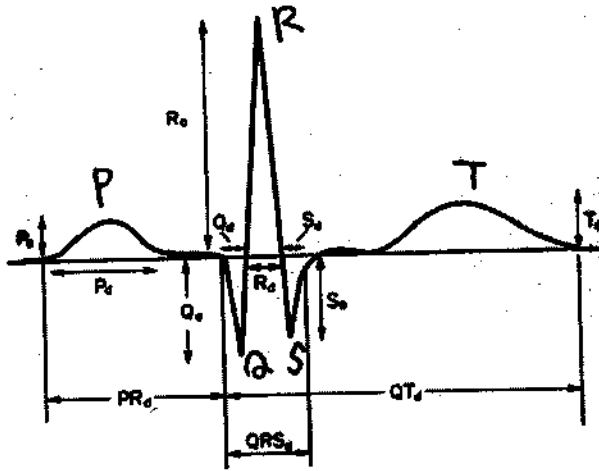

P: 심방 수축, QRS: 심실 수축  
 T: 심실 이완, PR: 심실 filling

⑤

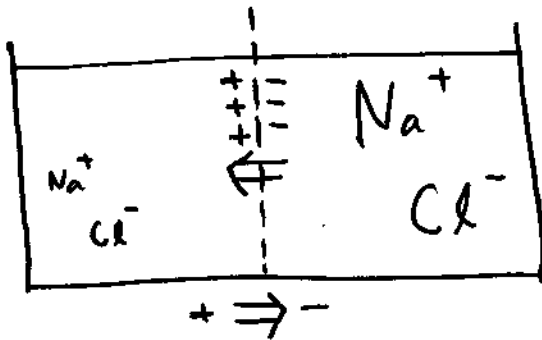

$Na^+$ 는 오른쪽에서 왼쪽으로 확산하여 이동한다.  
 $Na^+$ 가 오른쪽으로 이동함에 따라 막의 안쪽에는  
 + 전하가, 밖쪽에는 - 전하가 생겨서 국부적인  
 전하이중층 (charge double layer)이 형성된다,  
 이에 따라 전기차 및 전계도 형성된다. 이 전계는  
 $Na^+$ 의 확산을 막아하는 결국 동적 평형에 도달한다.

이동하는  $Na^+$ 의 양은 매우 적으므로, 용액의 농도변화는 무시할 수 있다.  $\lambda$ , 원쪽은 0.01 mole/l, 오른쪽은 0.1 mole/l 이다.

전위차  $E = 0.0615 \log_{10} \frac{0.1}{0.01} = 61.5 \text{ mV}$

이므로, 왼쪽이 + 이며 오른쪽이 - 이다.

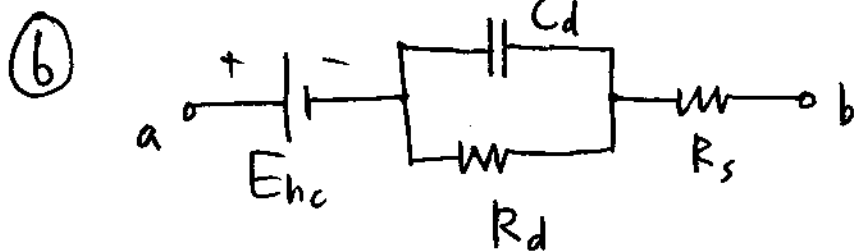

$$E_{hc} = 200 \text{ mV}$$

$$f = 0 \text{ mHz} \quad R_d + R_s = 60,000 \Omega$$

$$f = \infty \text{ mHz} \quad R_s = 600 \Omega$$

$$\therefore R_d = 59,400 \Omega$$

$$Z_{ab} = R_s + \frac{R_d \frac{1}{j\omega C_d}}{R_d + \frac{1}{j\omega C_d}} = R_s + \frac{R_d}{1 + j\omega R_d C_d}$$

$$= \frac{R_s + R_d + j\omega R_s R_d C_d}{1 + j\omega R_d C_d} \quad \text{이므로}$$

$$\frac{1}{2\pi R_d C_d} = 100 \text{ Hz} \text{ mHz} \quad C_d = 26.8 \text{ nF}$$

17

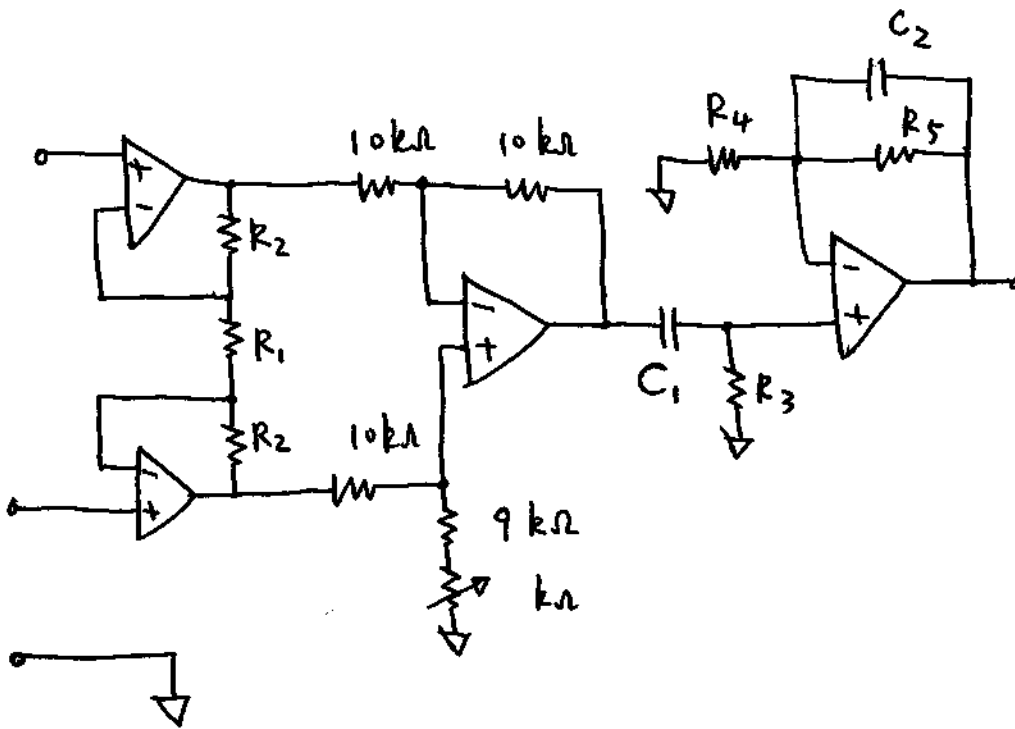

$$1 + 2 \frac{R_2}{R_1} = 25 \quad \text{για} \quad R_1 = 1 \text{ k}\Omega, \quad R_2 = 12 \text{ k}\Omega$$

$$\frac{1}{2\pi R_3 C_1} = 0.5 \text{ Hz} \quad \text{για} \quad R_3 = 1 \text{ M}\Omega, \quad C_1 = 0.32 \mu\text{F}$$

$$1 + \frac{R_5}{R_4} = 40 \quad \text{για} \quad R_4 = 1 \text{ k}\Omega, \quad R_5 = 39 \text{ k}\Omega$$

$$\frac{1}{2\pi R_5 C_2} = 100 \text{ Hz} \quad \text{για} \quad C_2 = 40.8 \text{ nF}$$